



Pressure transmitter

Huba Control

Relative pressure transmitter for shipbuilding Type 522



The compact type 522 pressure transmitter for shipbuilding is based upon the Huba Control developed thick film technology where the pressure measuring cell is fully welded.

The pressure measuring cell incorporates a fully welded construction within the transducer housing. Highest requirements in various applications concerning burst can be met.

All pressure transmitters of type 522 have the most important certifications for the shipbuilding industry.

Pressure range
0 ... 2.5 – 1000 bar

- + Compact, rugged construction
- + Welded without sealing parts
- + Certified for shipbuilding with:
 - American Bureau of Shipping
 - Bureau Veritas
 - Det Norske Veritas Germanischer Lloyd
 - Lloyd`s Register

Technical overview

Pressure range

Relative 0 ... 2.5 – 1000 bar

Operating conditions

Medium		Liquids, gases and refrigerants (incl. ammonia)
Temperature	Medium	-40 ... +135 °C (Ex) -30 ... +120 °C
	Ambient	-30 ... +85 °C (Ex) -25 ... +85 °C
	Storage	-50 ... +100 °C
Tolerable overload	≤ 6 bar	5 x FS
	> 6 bar	3 x FS (max. 1500 bar)
Rupture pressure	≤ 6 bar	10 x FS
	> 6 bar	6 x FS (max. 2500 bar)

Materials

Cover		Stainless steel 1.4404 / AISI 316L
Plug accommodation		Polyarylamide 50% GF UL 94 V-0
Materials in contact with medium	Pressure connection	Stainless steel 1.4404 / AISI 316L
	Sensor	Stainless steel

Electrical overview

	Output	Power supply	Load	Current consumption
2 wire	4 ... 20 mA	7 ... 33 VDC	< $\frac{\text{supply voltage} - 7 \text{ V}}{0.02 \text{ A}}$ [Ohm]	< 23 mA
	(Ex) 4 ... 20 mA	10 ... 30 VDC	< $\frac{\text{supply voltage} - 10 \text{ V}}{0.02 \text{ A}}$ [Ohm]	< 23 mA
3 wire	0 ... 10 V	12 ... 33 VDC	> 10 kOhm / < 100 nF	< 7 mA
Polarity reversal protection	Short circuit proof and protected against polarity reversal. Each connection is protected against crossover up to max. supply voltage.			
Insulation voltage	standard			500 VDC

Dynamic response

Response time	< 2 ms, 1 ms typ.
Load cycle	< 100 Hz

Electrical connection

	Protection standard	Protection class
Swift connector with or without cable 1.5 m (PVC spec.)	IP 67	III
Connector DIN EN 175301-803-A	IP 65	III
Connector M12x1	IP 67	III

Pressure connection

Inside thread	$\frac{1}{16}$ - 20 UNF	
	$\frac{1}{2}$ - 14 NPT	(≤ 60 bar)
Outside thread	$\frac{1}{16}$ - 20 UNF	sealing cone 45°
	$\frac{1}{4}$ - 18 NPT	
	G $\frac{1}{4}$	sealed at back DIN EN ISO 1179-2 with Profile seal ring in FPM (-30 ... +135 °C)
	G $\frac{1}{2}$	sealed at back and manometer (combi) with Profile seal ring in FPM (-30 ... +135 °C)
	M20x1.5	sealed at front and manometer (combi)
	G $\frac{1}{2}$	sealed at front

Installation arrangement

Unrestricted

Tests / Admissions

Electromagnetic compatibility	CE conformity acc. EN 61326-2-3
Shock acc. IEC IEC 68-2-27	100 g, 11 ms half sine wave, all 6 directions, free fall from 1 m on concrete (6x)
Constant shock acc. IEC 68-2-29	40 g for 6 ms, 1000x all 3 directions
Vibration acc. IEC 68-2-6	20 g, 15 ... 2000 Hz, 15 ... 25 Hz with amplitude ± 15 mm, 1 Octave/min. all 3 directions, 50 constant load
Shipbuilding	American Bureau of Shipping (ABS)
	Bureau Veritas (BV)
	Det Norske Veritas Germanischer Lloyd (DNV GL)
Drinking water approval	Lloyd's Register (LR)
EAC	WRAS

Protection against explosion (Ex)

Intrinsic safety "i" (with current output only)	4 ... 20 mA
EC type examination certificate	Ex II 1/2 G Ex ia IIC T4 Ga/Gb
Connection to certified intrinsically safe resistive circuits with maximum values	Ex II 1/2 D Ex ia IIC T125°C Da/Db
Effective internal inductance and capacitance for versions with plugs complying with EN 175301-803-A or M12x1	SEV 10 ATEX 0145
IECEX	Ui = 30 VDC; Ii = 100 mA = Pi = 0.75 W
	Li = 0 nH; Ci = 0 nF
	SEV 16.0007

Weight

~ 90 g

Packaging (Please state on order)

Single packaging in cardboard	accessories integrated
Multiple packaging in cardboard (25 pcs)	

Accuracy

Parameter	Unit	
Characteristic line ¹⁾	% fs	± 0.3
Resolution	% fs	0.1
Thermal characteristic ²⁾	max. % fs/10K	± 0.2
Long term stability acc. IEC EN 60770-1	max. % fs	± 0.25

Test conditions: 25 °C, 45% RH, power supply 24 VDC

¹⁾ typ. ; max. 0.5% fs (incl. zero point, full scale, linearity, hysteresis and repeatability)

²⁾ -15 ... 85 °C

			1	2	3	4	5	6	7	8	9	10	11		
Order code selection table in bar			522.	X	X	X	X	X	X	X	X	X	X	X	
Pressure range ¹⁾	0 ... 2.5 bar		9	1	4	S	0								
	0 ... 4 bar		9	1	5	S	0								
	0 ... 6 bar		9	1	7	S	0								
	0 ... 10 bar		9	3	0	S	0								
	0 ... 16 bar		9	3	1	S	0								
	0 ... 25 bar		9	3	2	S	0								
	0 ... 40 bar		9	3	3	S	0								
	0 ... 60 bar		9	4	0	S	0								
	0 ... 100 bar		9	4	1	S	0								
	0 ... 160 bar		9	4	2	S	0								
	0 ... 250 bar		9	4	3	S	0								
	0 ... 400 bar		9	5	4	S	0								
	0 ... 600 bar		9	5	5	S	0								
0 ... 1000 bar ²⁾		9	5	7	S	0									
Output / power supply	0 ... 10 V	12 ... 33 VDC							2						
	4 ... 20 mA	7 ... 33 VDC							3						
		10 ... 30 VDC	Ex protection							4	1,3				
Electrical connection	Connector	DIN EN 175301-803-A ³⁾								1					
		M12x1 ³⁾ 2w: IN=1 / OUT=3 3w: IN=1 / OUT=4 / GND=3									3				
		M12x1 ³⁾ 2w: IN=1 / OUT=4 3w: IN=1 / OUT=3 / GND=4										M			
		Swift connector with cable 1.5 m										L			
Pressure connection	Inside thread	7/16 - 20 UNF									K	0	1		
		1/2 - 14 NPT (≤ 60 bar)										D	0	1	
		7/16 - 20 UNF										2	0	1	
	Outside thread	1/4 - 18 NPT										3	0	1	
		G 1/4 sealed at back DIN EN ISO 1179-2 with Profile seal ring in FPM										4	0	1	
		G 1/2 sealed at back and manometer with Profile seal ring in FPM										8	0	1	
Pressure range variation (optional)	Indicate W and state range on order (e.g.: W0... + 3bar/OUT0...5V)	M20x1.5 sealed at front and manometer (combi)									E	0	1		
		G 1/2 sealed at front										9	0	1	
															W

			1	2	3	4	5	6	7	8	9	10	11		
Order code selection table in psi			522.	X	X	X	X	X	X	X	X	X	X	X	
Pressure range ¹⁾	0 ... 30 psi		9	B	4	S	0								
	0 ... 60 psi		9	B	5	S	0								
	0 ... 100 psi		9	B	7	S	0								
	0 ... 200 psi		9	C	1	S	0								
	0 ... 300 psi		9	C	2	S	0								
	0 ... 500 psi		9	C	3	S	0								
	0 ... 750 psi		9	D	0	S	0								
	0 ... 1000 psi		9	D	1	S	0								
	0 ... 2000 psi		9	D	2	S	0								
	0 ... 3000 psi		9	D	3	S	0								
	0 ... 5000 psi		9	E	4	S	0								
	0 ... 7500 psi		9	E	5	S	0								
	0 ... 14500 psi ⁴⁾		9	E	7	S	0								
	Output / power supply	0 ... 10 V	12 ... 33 VDC							2					
		4 ... 20 mA	7 ... 33 VDC								3				
10 ... 30 VDC			Ex protection								4	1,3			
Electrical connection	Connector	DIN EN 175301-803-A ³⁾									1				
		M12x1 ³⁾ 2w: IN=1 / OUT=3 3w: IN=1 / OUT=4 / GND=3										3			
		M12x1 ³⁾ 2w: IN=1 / OUT=4 3w: IN=1 / OUT=3 / GND=4											M		
		Swift connector with cable 1.5 m											L		
Pressure connection	Inside thread	7/16 - 20 UNF										K	0	1	
		1/2 - 14 NPT (≤ 870 psi)											D	0	1
		7/16 - 20 UNF											2	0	1
	Outside thread	1/4 - 18 NPT											3	0	1
		G 1/4 sealed at back DIN EN ISO 1179-2 with Profile seal ring in FPM											4	0	1
		G 1/2 sealed at back and manometer with Profile seal ring in FPM											8	0	1
Pressure range variation (optional)	Indicate W and state range on order (e.g.: W0... + 400psi/OUT0...5V)	M20x1.5 sealed at front and manometer (combi)										E	0	1	
		G 1/2 sealed at front											9	0	1
															W

¹⁾ Other pressure ranges on request
³⁾ Delivery without female connector

²⁾ DNV-GL and LR approvals, pressure range 0 ... 1000 bar available. ABS and BV approvals only available up to 0 ... 600 bar.
⁴⁾ DNV-GL and LR approvals, pressure range 0 ... 14500 psi available. ABS and BV approvals only available up to 0 ... 7500 psi.

Order code selection table in MPa			1	2	3	4	5	6	7	8	9	10	11	
			522.	X	X	X	X	X	X	X	X	X	X	
Pressure range ¹⁾	0 ... 0.25 MPa		9	G	4	S	0							
	0 ... 0.4 MPa		9	G	5	S	0							
	0 ... 0.6 MPa		9	G	7	S	0							
	0 ... 1 MPa		9	H	0	S	0							
	0 ... 1.6 MPa		9	H	1	S	0							
	0 ... 2.5 MPa		9	H	2	S	0							
	0 ... 4 MPa		9	H	3	S	0							
	0 ... 6 MPa		9	K	0	S	0							
	0 ... 10 MPa		9	K	1	S	0							
	0 ... 16 MPa		9	K	2	S	0							
	0 ... 25 MPa		9	K	3	S	0							
	0 ... 40 MPa		9	L	4	S	0							
	0 ... 60 MPa		9	L	5	S	0							
0 ... 100 MPa ²⁾		9	L	7	S	0								
Output / power supply	0 ... 10 V	12 ... 33 VDC							2					
	4 ... 20 mA	7 ... 33 VDC							3					
		10 ... 30 VDC	Ex protection						4	1,3				
Electrical connection	Connector	DIN EN 175301-803-A ³⁾								1				
		M12x1 ³⁾	2w: IN=1 / OUT=3	3w: IN=1 / OUT=4 / GND=3						3				
		M12x1 ³⁾	2w: IN=1 / OUT=4	3w: IN=1 / OUT=3 / GND=4							M			
		Swift connector with cable 1.5 m									L			
Pressure connection	Inside thread	7/16 - 20 UNF									K	0	1	
		1/2 - 14 NPT (≤ 6 MPa)									D	0	1	
		7/16 - 20 UNF										2	0	1
	Outside thread	1/4 - 18 NPT										3	0	1
		G 1/4 sealed at back DIN EN ISO 1179-2 with Profile seal ring in FPM										4	0	1
		G 1/2 sealed at back and manometer with Profile seal ring in FPM										8	0	1
Pressure range variation (optional)	Indicate W and state range on order (e.g.: W0... + 0.3MPa/OUT0...5V)	M20x1.5 sealed at front and manometer (combi)									E	0	1	
		G 1/2 sealed at front										9	0	1
														W

Accessories (supplied loose)	Order number
Female connector DIN EN 175301-803-A with seal	103510
Corner-wire box for connector M12x1	106975
Corner-wire box for connector M12x1 with cable 2.0 m	114604
Straight-wire box for connector M12x1	114570
Straight-wire box for connector M12x1 with cable 2.0 m	114605
Mounting bracket with screw	118716
Heat sink with outside thread G 1/2 sealed at front - inside thread G 1/2	105631
Heat sink with outside thread G 1/2 sealed at front - inside thread G 1/4	105073
Heat sink with outside thread G 1/4 sealed at front - inside thread G 1/4	105074
Calibration certificate (only until 600 bar possible)	104551

Mounting bracket

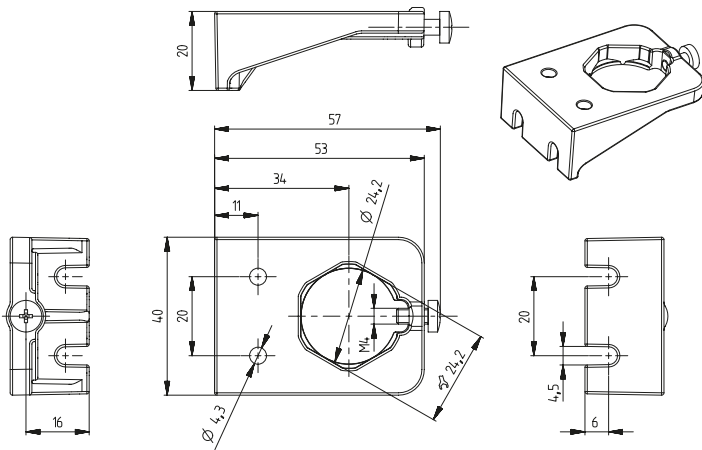

Heat sink

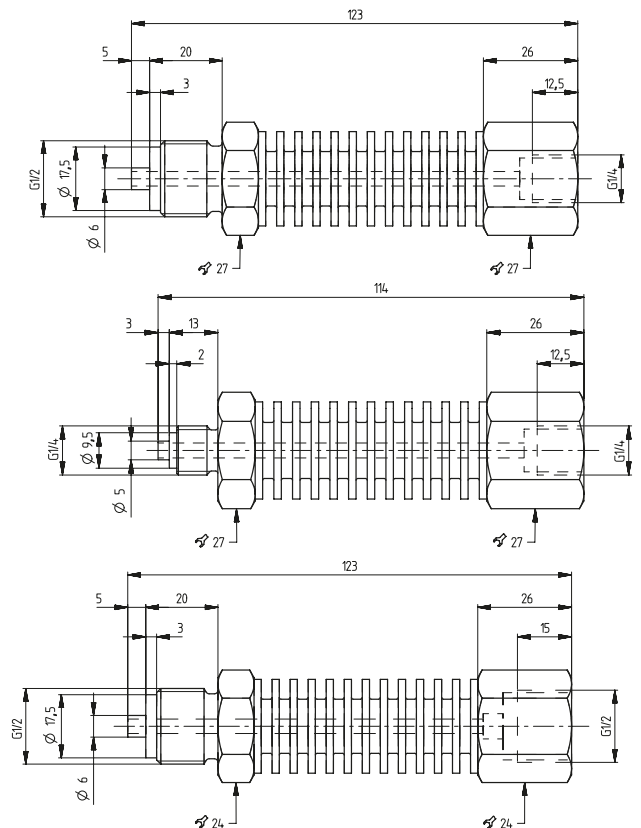

¹⁾ Other pressure ranges on request

²⁾ DNV-GL and LR approvals, pressure range 0 ... 100 MPa available. ABS and BV approvals only available up to 0 ... 60 MPa.

³⁾ Delivery without female connector

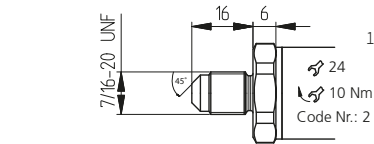
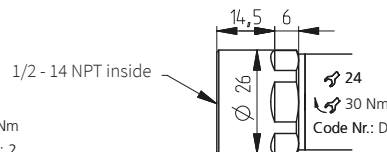
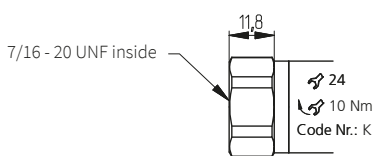
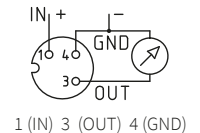
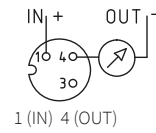
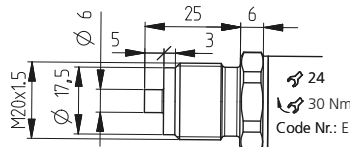
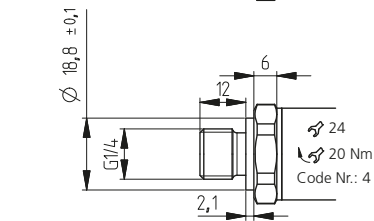
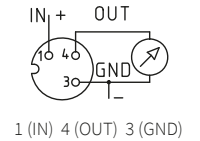
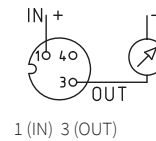
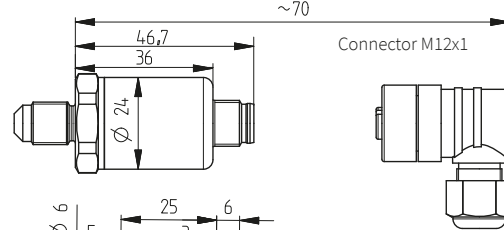
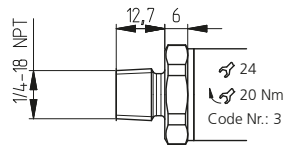
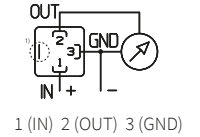
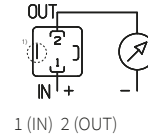
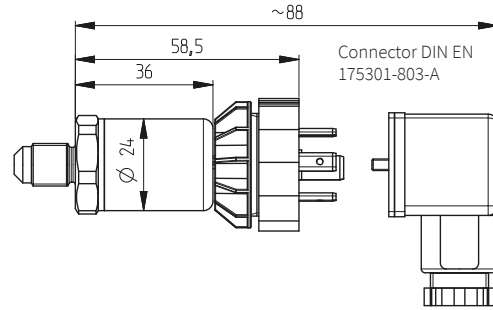
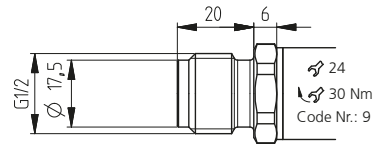
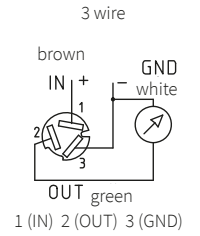
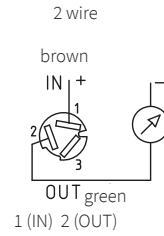
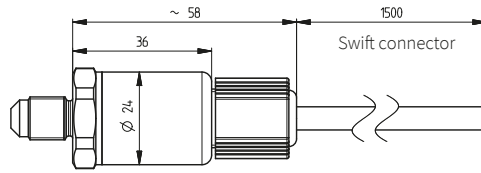
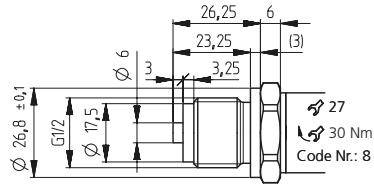

Ex

Device design with explosion protection: 4 ... 20 mA
The grounding connection is conductively connected to the transmitter housing.

Connector DIN EN 175301-803-A

1 (IN) 2 (OUT) ↓

Connector M12x1

1 (IN) 3 (OUT) 4 (↓)

¹⁾ Not connected with transmitter housing

Huba Control AG

Industriestrasse 17
5436 Würenlos, Switzerland
Tel. +41 56 436 82 00
info.ch@hubacontrol.com



Consultancy in your area
hubacontrol.com/en/worldwide

